

Report Prepared On: 08/02/13

Structured Product Details

Name	Leveraged Equity Index-Linked Notes linked to S&P 500 Index
Issue Size	\$9.12 million
Issue Price	\$1,000
Term	19 Months
Annualized Coupon	0.00%
Pricing Date	January 9, 2012
Issue Date	January 17, 2012
Valuation Date	July 24, 2013
Maturity Date	July 31, 2013
Issuer	Royal Bank of Canada
CDS Rate	116.86 bps
Swap Rate	0.87%
Reference Asset	the S&P 500 Index
Initial Level	1,280.55
Dividend Rate	2.07%
Implied Volatility Delta¹	23.21% 0.71
Fair Price at Issue	\$918.75
Realized Return	12.59%
CUSIP	78010V774
SEC Link	www.sec.gov/Archives/edgar/data/1000275/000121465912000128/s112121424b2.htm

Leveraged Equity Index-Linked Notes linked to S&P 500 Index

Description

Royal Bank of Canada issued \$9.12 million of Leveraged Equity Index-Linked Notes linked to S&P 500 Index on January 17, 2012 at \$1,000 per note.

These notes are Royal Bank of Canada-branded PLUS securities that do not pay periodic coupons, but instead pay a single amount at maturity depending on the S&P 500 Index level at maturity.

If the S&P 500 Index level on July 24, 2013 is higher than 1,280.55, but lower than 1,331.77, the notes pay a return equal to the percentage increase in the S&P 500 Index multiplied by 5.0. If on July 24, 2013 the S&P 500 Index level is above the 1,331.77, the notes pay the maximum payout of \$1,200.00. If on July 24, 2013 the S&P 500 Index level is below 1,280.55, investors receive the face value per note reduced by the percentage decline in the reference asset. The notes will pay nothing at maturity if the reference asset declines to zero.

Valuation

This note can be valued as a combination of a note from Royal Bank of Canada, a short at-the-money put option, 5.0 long at-the-money call options, and 5.0 short out-of-the-money call options. The short at-the-money put option exposes investors to any decline in the S&P 500 Index. The 5.0 short out-of-the-money call options has the strike price of 1,331.77, and limits the maximum return of the notes beyond the cap level. For reasonable valuation inputs this note was worth \$918.75 when it was issued on January 17, 2012 because the value of the options investors gave Royal Bank of Canada plus the interest investors would have received on Royal Bank of Canada's straight debt was worth \$81.25 more than the call options investors received from Royal Bank of Canada.

There is no active secondary market for most structured products. Structured products, including this note, therefore are much less liquid than simple stocks, bonds, notes and mutual funds. Investors are likely to receive less than the structured product's estimated market value if they try to sell the structured product prior to maturity. Our valuations do not incorporate this relative lack of liquidity and therefore should be considered an upper bound on the value of the structured product.

Payoff Curve at Maturity

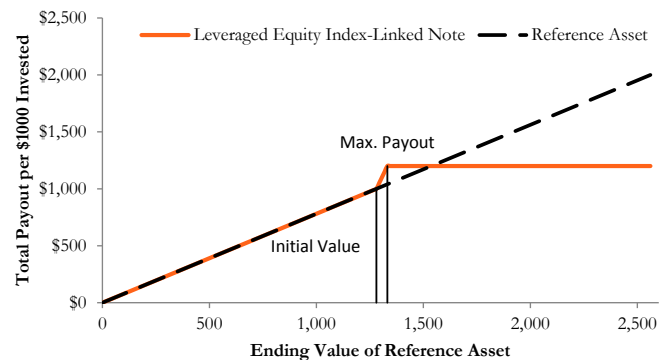

The payoff diagram shows the final payoff of this note given the S&P 500 Index level (horizontal axis). For comparison, the dashed line shows the payoff if you invested in the S&P 500 Index directly.

Related Research

Research Papers:

www.slcg.com/research.php

- "Are Structured Products Suitable for Retail Investors?" December 2006.
- "Structured Products in the Aftermath of Lehman Brothers," November 2009.
- "What TiVo and JP Morgan Teach Us about Reverse Convertibles," June 2010.

Tim Dulaney, Ph.D.,
Senior Financial Economist, SLCG
(+1) 703.539.6777
TimDulaney@slcg.com

Principal Payback Table

The S&P 500 Index	Note Payoff
0.00	\$0.00
128.06	\$100.00
256.11	\$200.00
384.17	\$300.00
512.22	\$400.00
640.28	\$500.00
768.33	\$600.00
896.39	\$700.00
1,024.44	\$800.00
1,152.50	\$900.00
1,280.55	\$1,000.00
1,408.61	\$1,200.00
1,536.66	\$1,200.00
1,664.72	\$1,200.00
1,792.77	\$1,200.00
1,920.83	\$1,200.00

Maturity Payoff Diagram

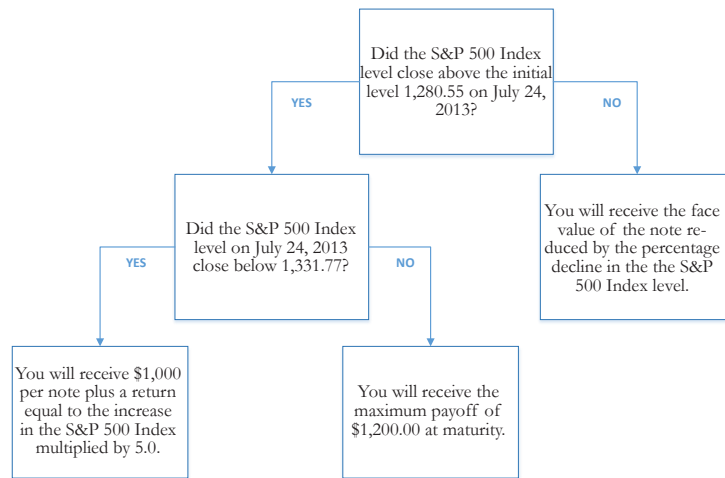

The contingent payoffs of this Leveraged Equity Index-Linked Note.

Analysis

This Leveraged Equity Index-Linked Note pays investors the increase in the S&P 500 Index multiplied by 5.0 capped at 20.00%, but if the S&P 500 Index declines over the term of the note, investors will suffer losses equal to the percentage decline in the S&P 500 Index. In addition, investors bear the credit risk of Royal Bank of Canada. Investors purchasing this Leveraged Equity Index-Linked Note effectively sell at-the-money put and out-of-the-money call options to Royal Bank of Canada, buy at-the-money call options, and a zero-coupon note from Royal Bank of Canada. This Leveraged Equity Index-Linked Note is fairly priced if and only if the market value of the options investors received from Royal Bank of Canada equals the market value of the options investors gave Royal Bank of Canada plus the interest investors would have received on Royal Bank of Canada's straight debt.

Royal Bank of Canada's Stock Price

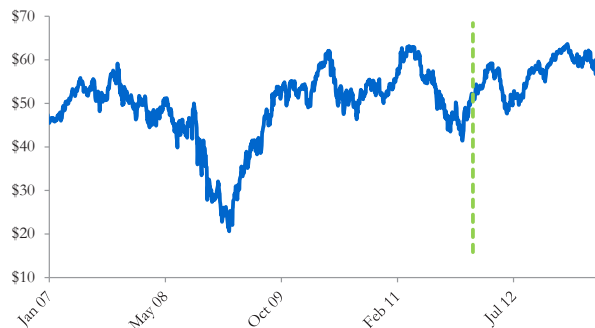

The graph above shows the adjusted closing price of the issuer Royal Bank of Canada for the past several years. The stock price of the issuer is an indication of the financial strength of Royal Bank of Canada. The adjusted price shown above incorporates any stock split, reverse stock split, etc.

Royal Bank of Canada's CDS Rate

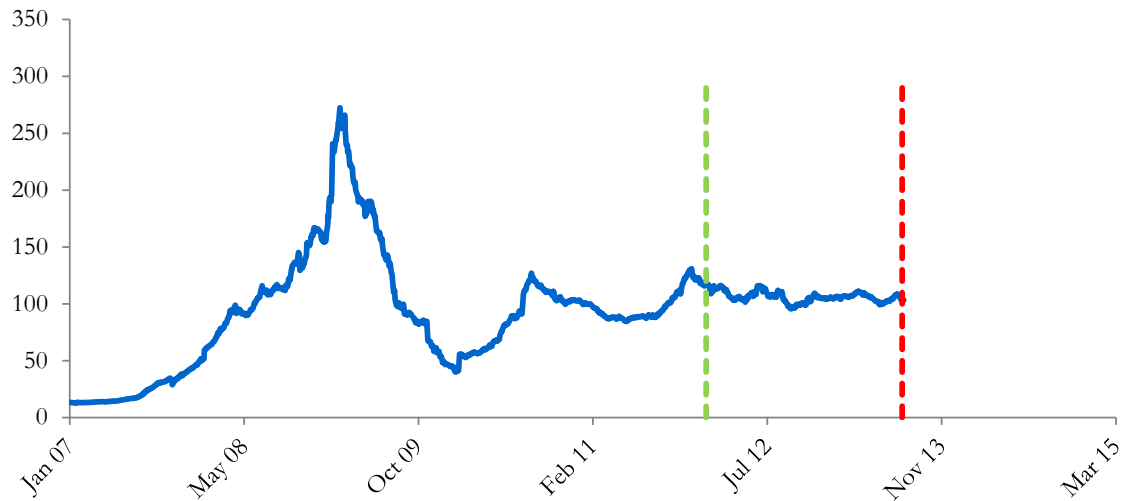

Credit default swap (CDS) rates are the market price that investors require to bear credit risk of an issuer such as Royal Bank of Canada. CDS rates are usually given in basis points (bps). One basis point equals 0.01%. Higher CDS rates reflect higher perceived credit risk, higher required yields, and therefore lower market value of Royal Bank of Canada's debt, including outstanding Leveraged Equity Index-Linked Note. Fluctuations in Royal Bank of Canada's CDS rate impact the market value of the notes in the secondary market.

The S&P 500 Index Level

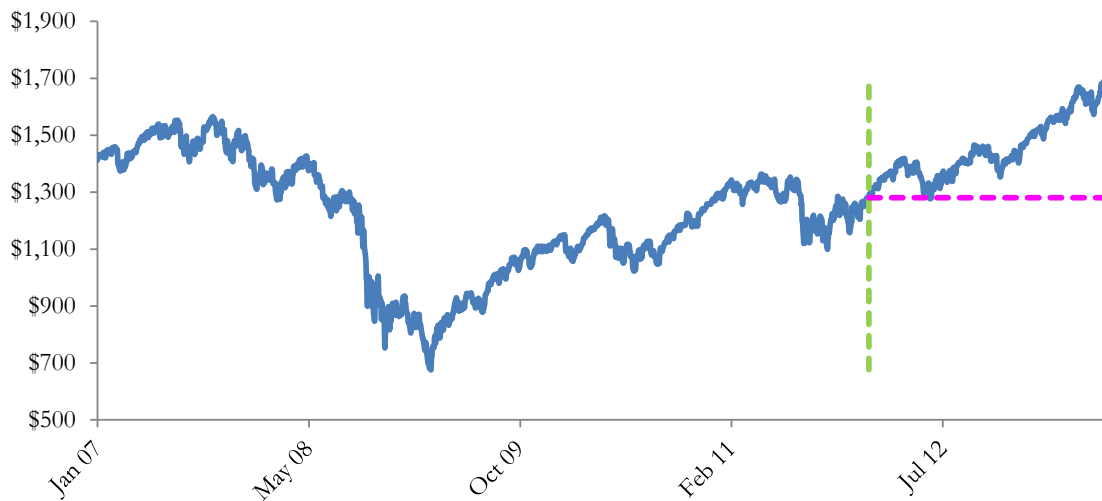

The graph above shows the historical levels of the S&P 500 Index for the past several years. The final payoff of this note is determined by the S&P 500 Index level at maturity. Higher fluctuations in the S&P 500 Index level correspond to a greater uncertainty in the final payout of this Leveraged Equity Index-Linked Note.

Realized Payoff

This note matured on July 31, 2013 and investors received \$1,200.00 per note.

Reference Asset The S&P 500 Index's Implied Volatility

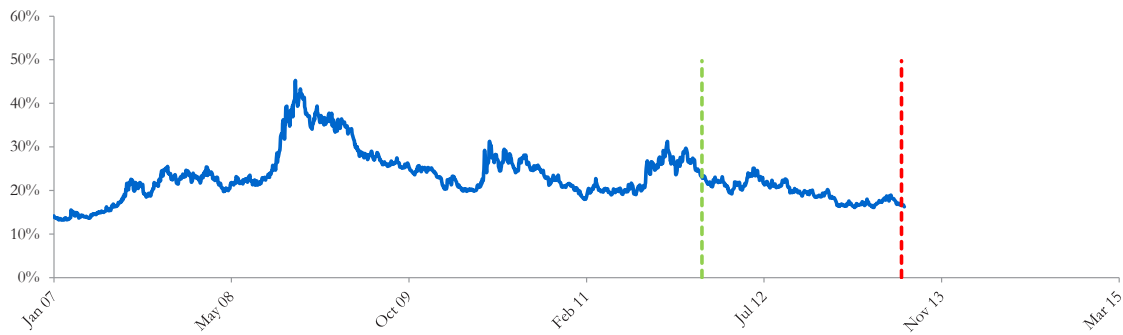

The annualized implied volatility of the S&P 500 Index on January 9, 2012 was 23.21%, meaning that options contracts on the S&P 500 Index were trading at prices that reflect an expected annual volatility of 23.21%. The higher the implied volatility, the larger the expected fluctuations of the S&P 500 Index level and of the Note's market value during the life of the Notes.

Decomposition of this Leveraged Equity Index-Linked Note

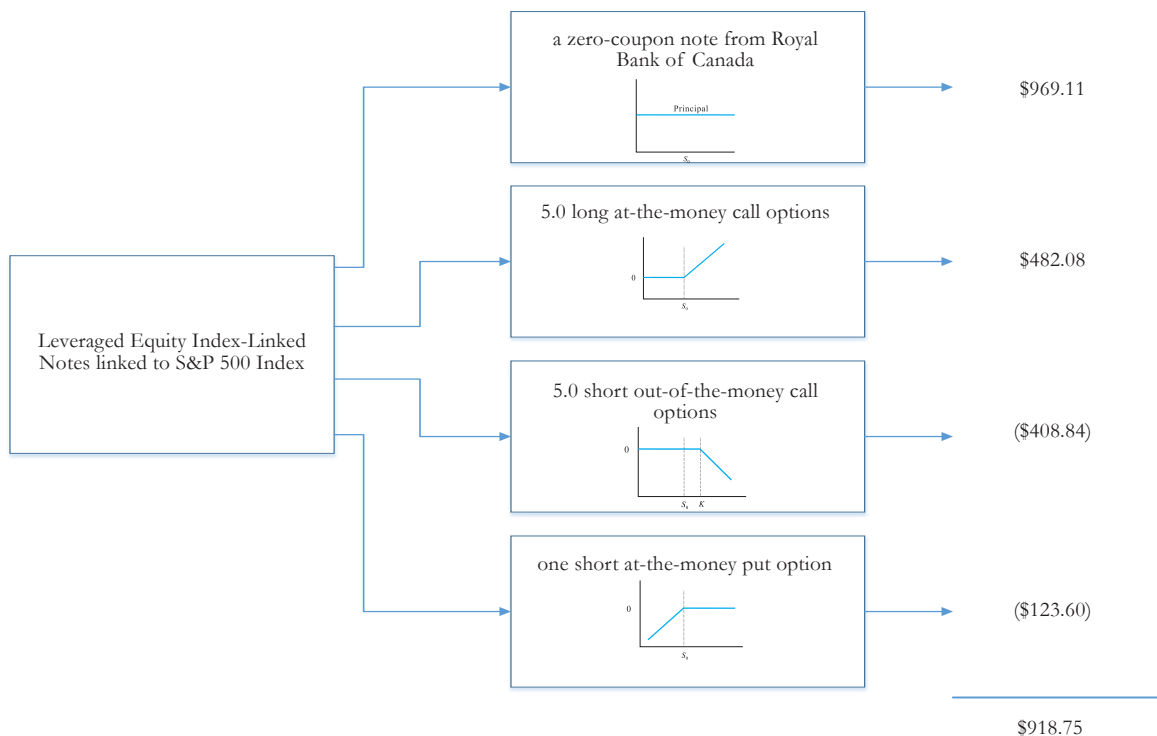

This note can be decomposed into different components, and each component can be valued separately. The chart above shows the value of each component of this Leveraged Equity Index-Linked Note.

1. Delta measures the sensitivity of the price of the note to the S&P 500 Index level on January 9, 2012.
2. CDS rates can be considered a measure of the probability that an issuer will default over a certain period of time and the likely loss given a default. The lower the CDS rate, the lower the default probability. CDS rate is given in basis points (1 basis point equals 0.01%), and is considered as a market premium, on top of the risk-free rate, that investors require to insure against a potential default.
3. Fair price evaluation is based on the Black-Scholes model of the S&P 500 Index on January 9, 2012.
4. Calculated payout at maturity is only an approximation, and may differ from actual payouts at maturity.
5. Our evaluation does not include any transaction fees, broker commissions, or liquidity discounts on the notes.